



MESY

Mobility and Energy storage Systems

T H E P O W E R - T O - G A S G R O U P

What we do...



New strategy for cost savings of Billions in the Energy Market

Very expensive and complex.

Requires Billions of Investments to stabilize Power Grids
(e.g. Germany 21 Milliarden €)

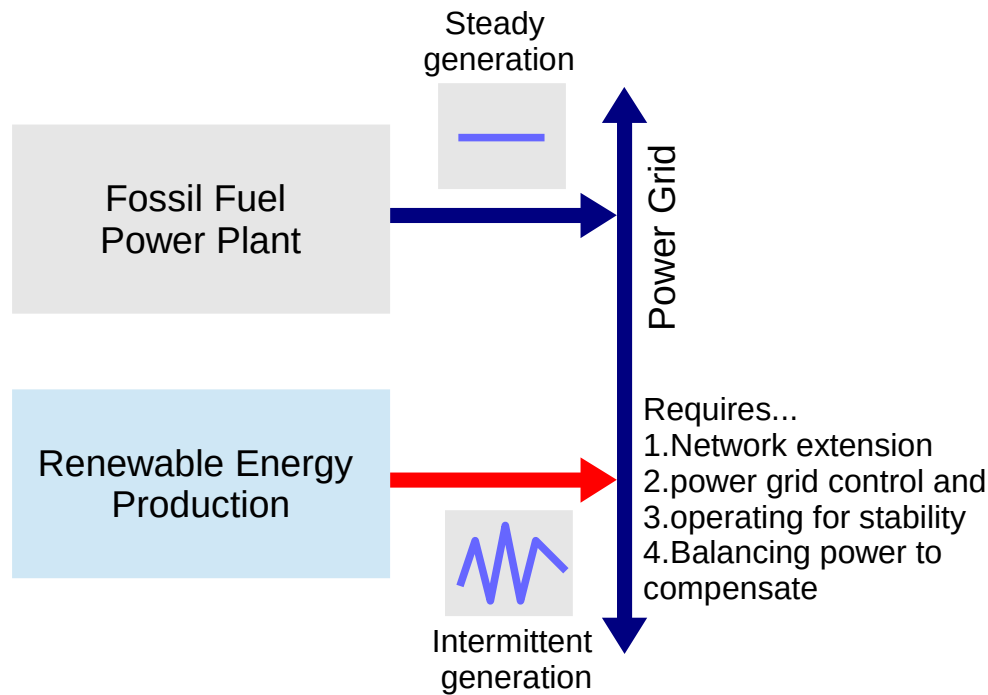

Very cheap and simple.

No Investments necessary to stabilize the power grids.

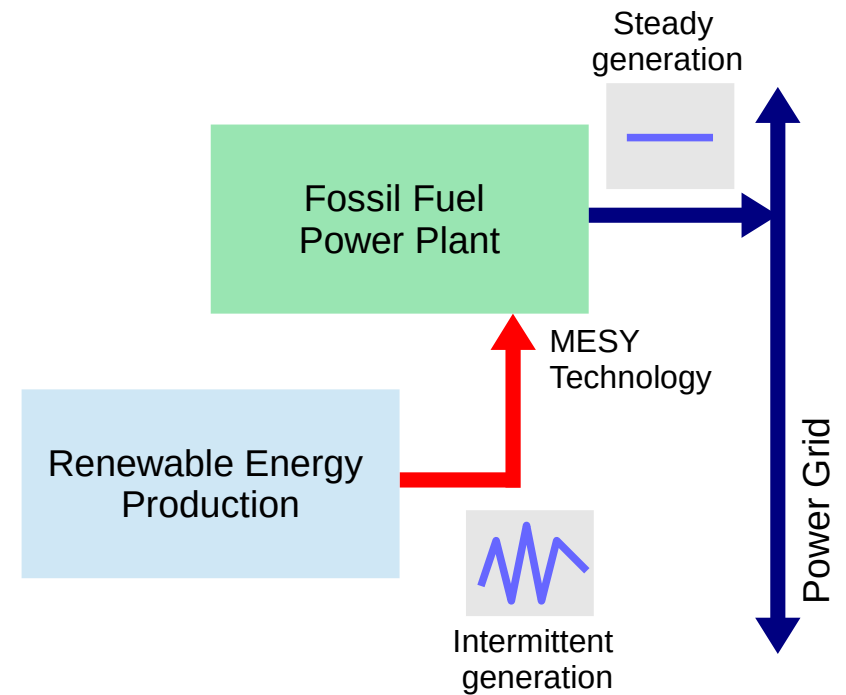

Economy effects for the energy markets

Copyright © 2014-2015 MESY GmbH



1. Examples

CO₂-Reduction without follow-up costs, worldwide

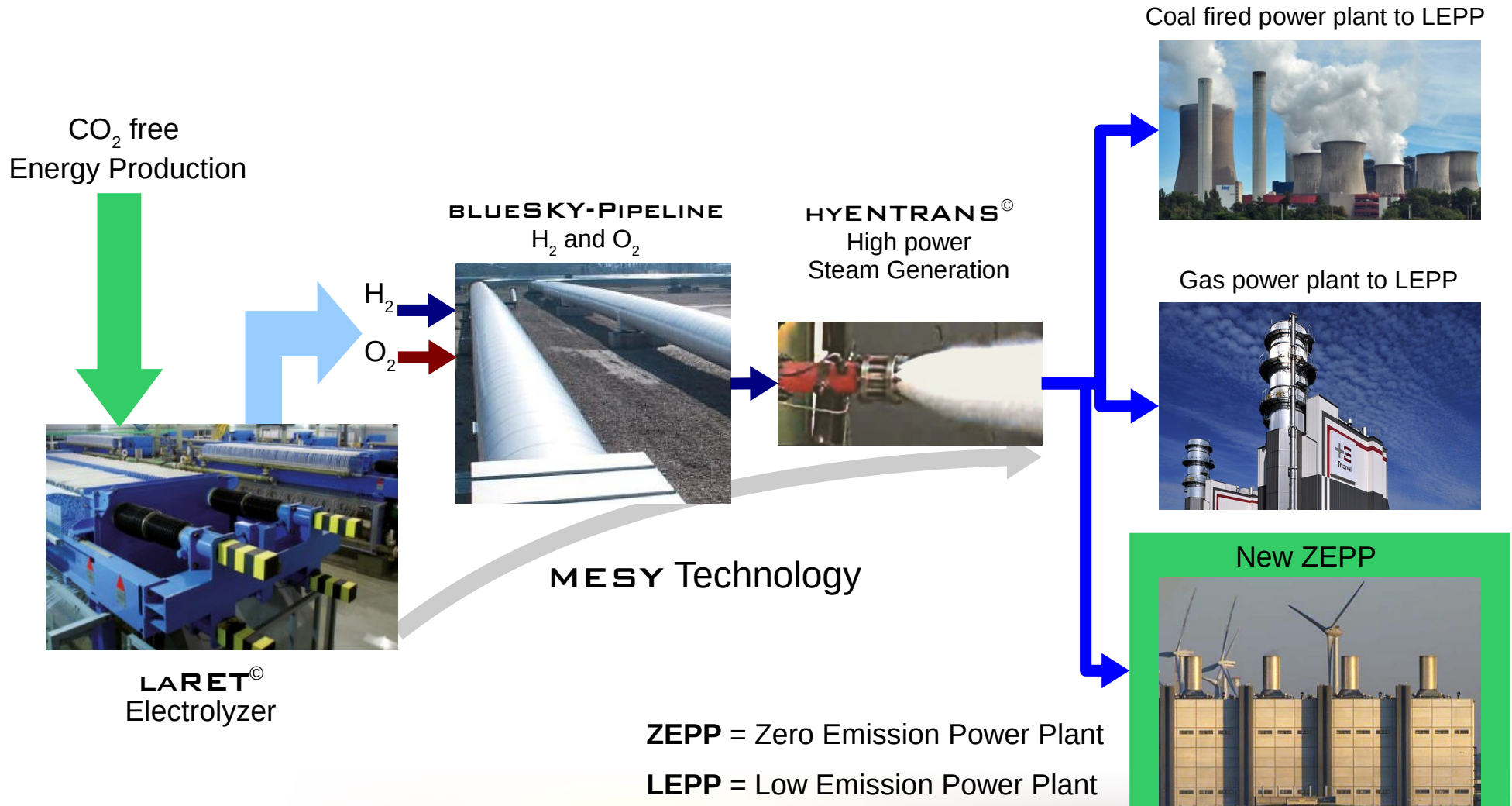

The Strategy of THOR

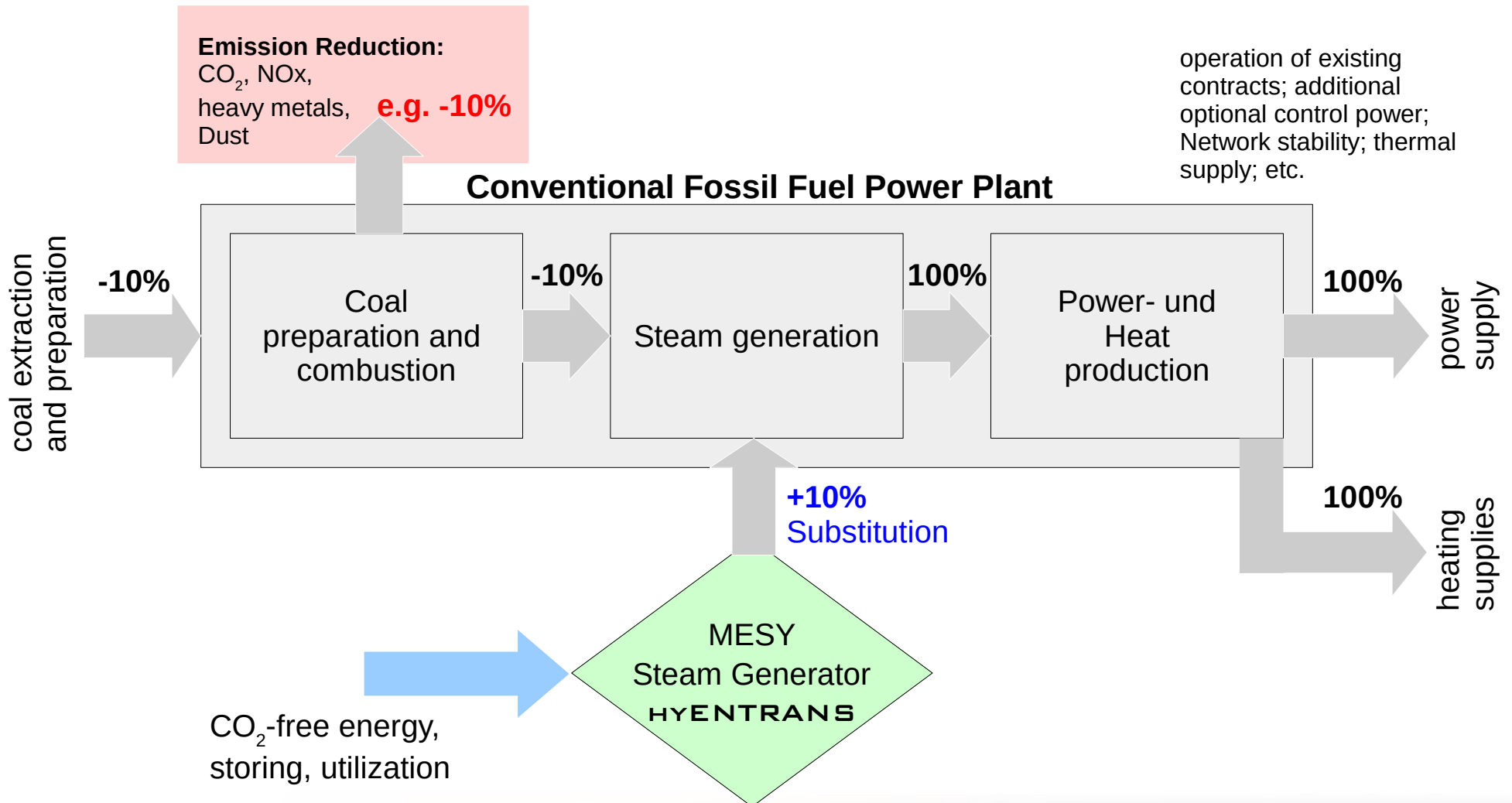

How it works?



The THOR project in the application

Expected effect

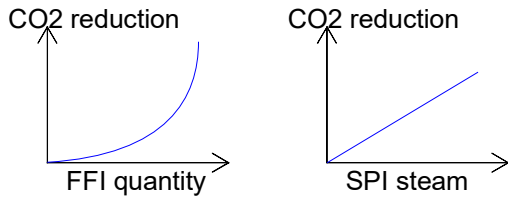

THOR requirements:

Input:

- Deionized water
- CO₂-free Electric power

Zero CO₂ Energy Production

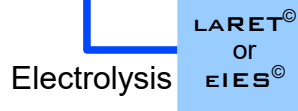

Example: Coal Fired Power Plant

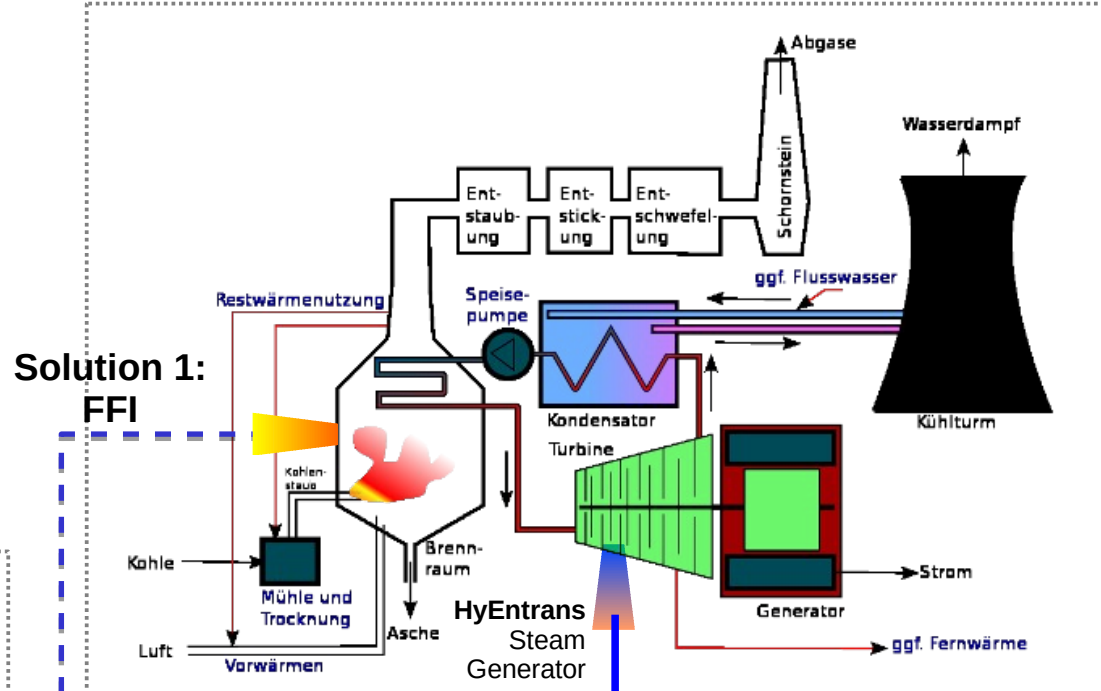

Solution 1: FFI

Solution 2: SPI

THOR products:

Output:

- Full flexible Electric power
- Steam
- Heat
- Gas (Hydrogen + Oxygen)



Products- and Interfaces: HYENTRANS Hydrogen Energy Transformation Facility

HYENTRANS[®] System Overview

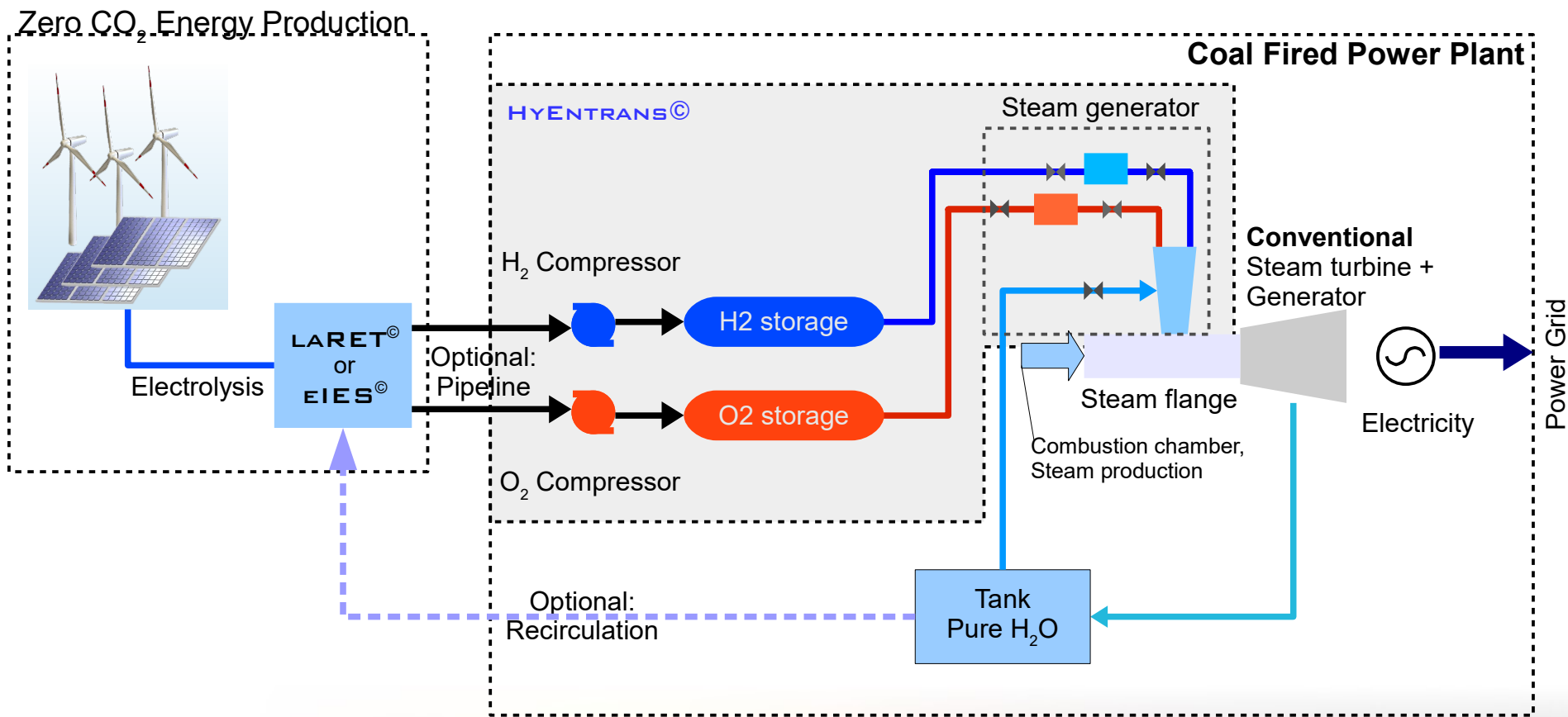

Key technology for the energy market

Copyright © 2014-2015 MESY GmbH



2. Example

Energy transport over very long distances

ZEPP = Zero Emission Power Plant

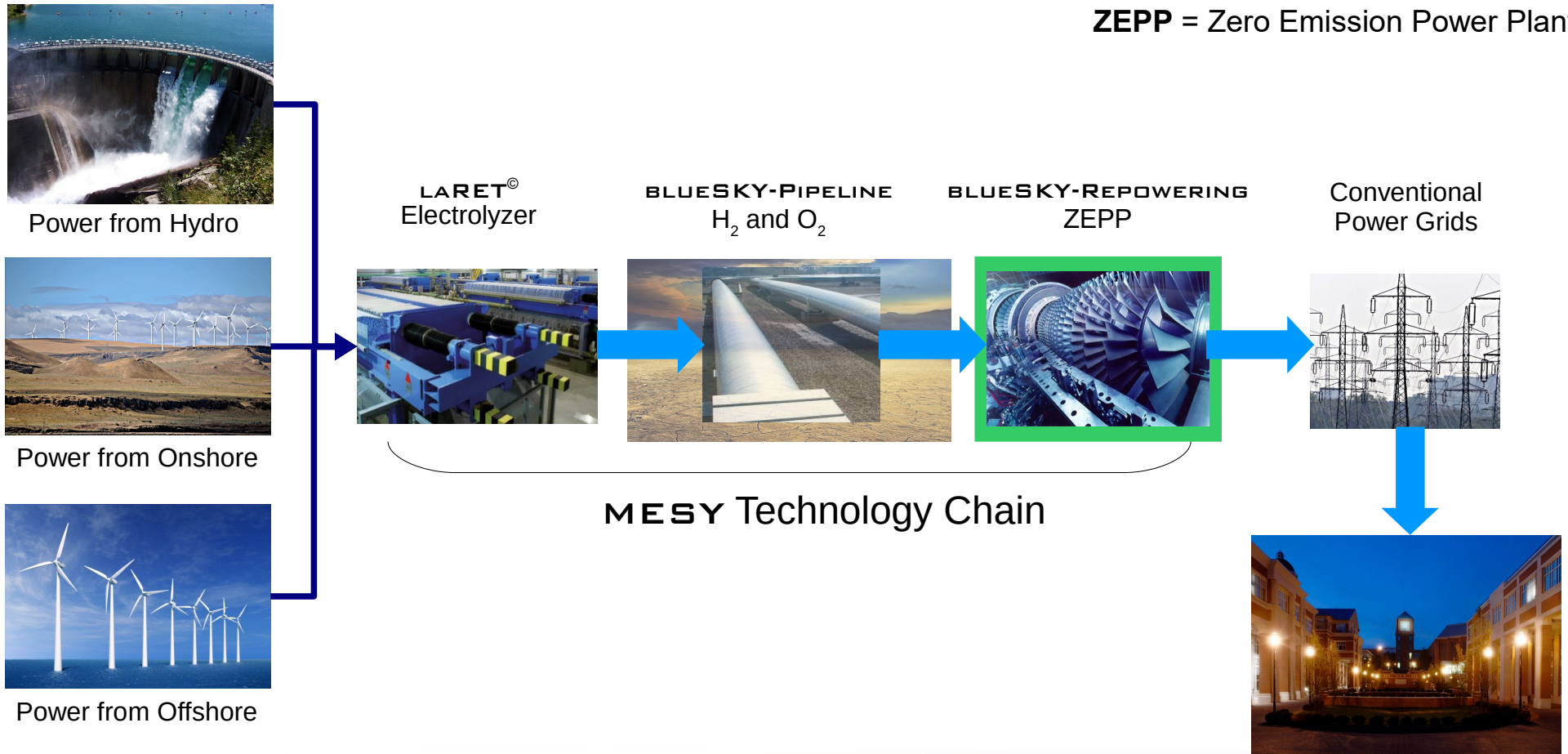

The combination of fossil energy production and renewable energy production reduces pollutant emissions drastically and save money.



Copyright © 2014-2015 MESY GmbH



Economy Effects of THOR

Benefit for fossil fuel power plant operators

- Reduction in CO₂ emissions with NO follow-up costs
- Fast control performance for supporting grid stability
- Simple and save installation
- Simple integration and control
- Simple and low costs of dismantling
- High performance compression per volume
- No changes to the existing facilities
- **In other countries:** Reduction of investments in the expansion of electricity networks, because fluctuating electricity production from wind farms are smoothed before being fed. (In Germany, the potential would **11 Bil.€** investment savings = 25% Renewable Energy Production (=total green energy production of 2014), appraisal ~50% of 21 Bil.€ planed investment of Germany “Network Development Plan”, Status 2013)

Expenditure

- Requires Green Energy and Transformation into gas for one or more power stations



Option for new power plants or installation in existing power plants

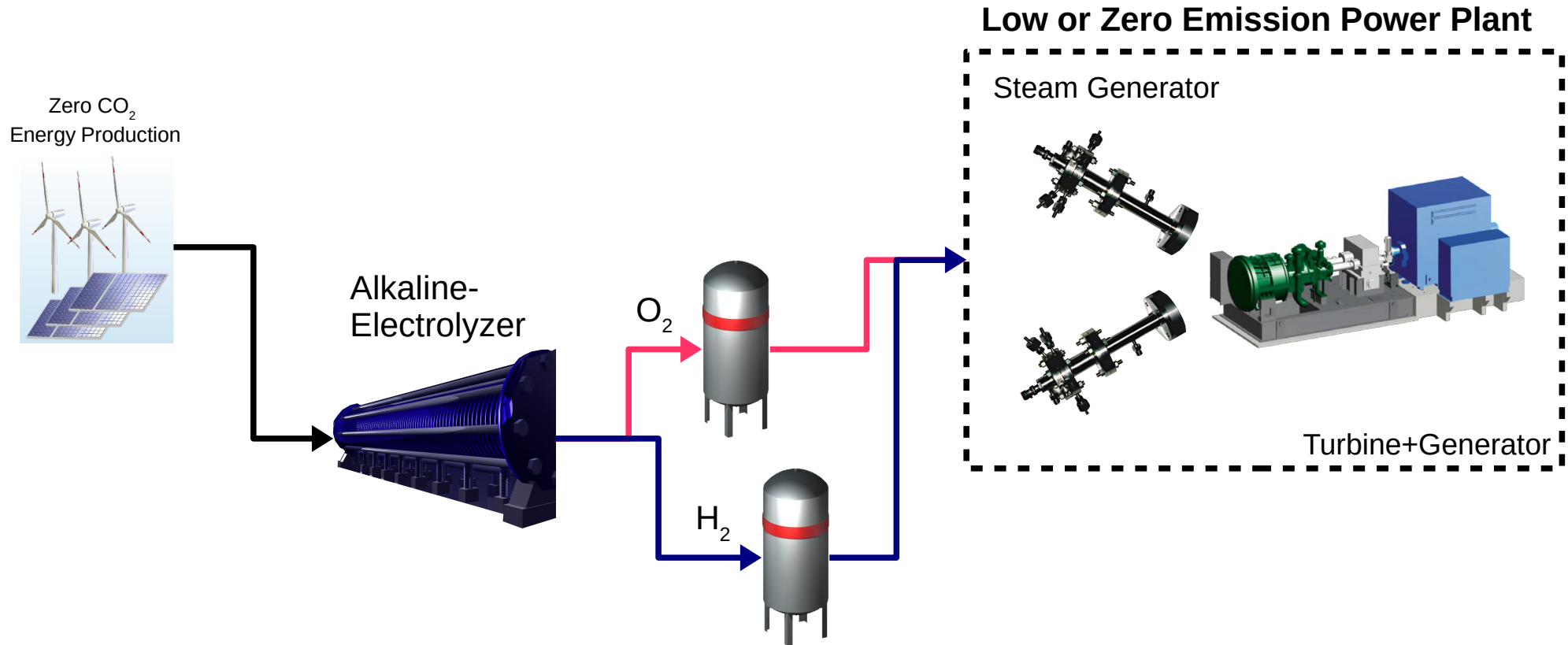

The 150 MW_{term} High Power Solution (LARET Option)



150 MW sample
to show how it works

Steam generator up to 150 MW per unit

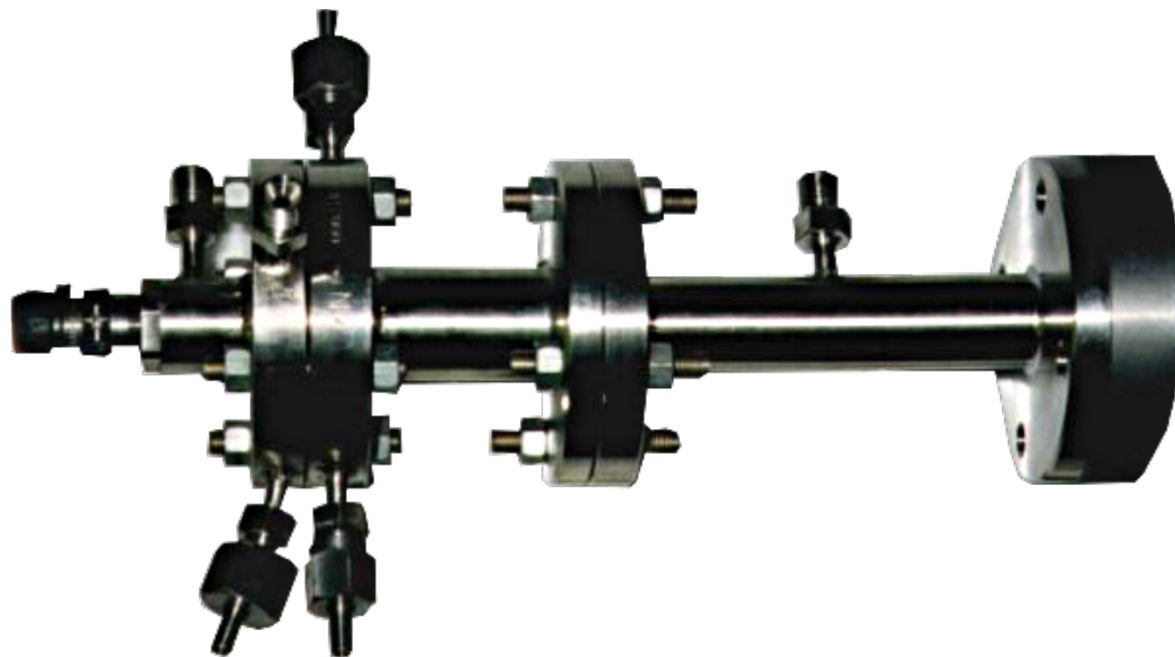

Copyright © 2014-2015 MESY GmbH



HYENTRANS Steam Generator

50 MW_{therm}

For 1 kg steam (Efficiency considered)

- 0,0182 kg H₂
- 0,1438 kg O₂
- 0,8380 kg H₂O
- 2757,1 kJ/kg steam (500°C / 80 bar)

For 50 MW steam (Efficiency considered)

Output:

- 18,13 kg/s steam with 500°C / 80 bar / ~ 50 MW

Input:

- 15,20 kg/s H₂O Water with ambient temperature / 100 bar
- 0,33 kg/s H₂ Hydrogen mit ambient temperature / 100 bar
- 2,61 kg/s O₂ Oxygen mit ambient temperature / 100 bar



Sample of a set of steam turbine and generator for the power industry from Siemens in combination with HYENTRANS Power up to 50 MWe (SST-300)

Technical data

- Power output up to 50 MW
- Speed up to 12,000 rpm
- Live steam conditions
 - Pressure up to 120 bar / 1,740 psi
 - Temperature up to 520 °C / 968 °F
- Bleed: Pressure up to 60 bar / 870 psi
- Controlled extraction (single or double)
 - Pressure up to 45 bar / 655 psi
 - Temperature up to 400 °C / 750 °F
- Exhaust steam pressure
 - Back pressure up to 16 bar / 232 psi
 - District heating up to 3 bar / 43 psi
 - Condensing up to 0.3 bar / 4.4 psi

(All data are approximate and project-related.)



SIEMENS

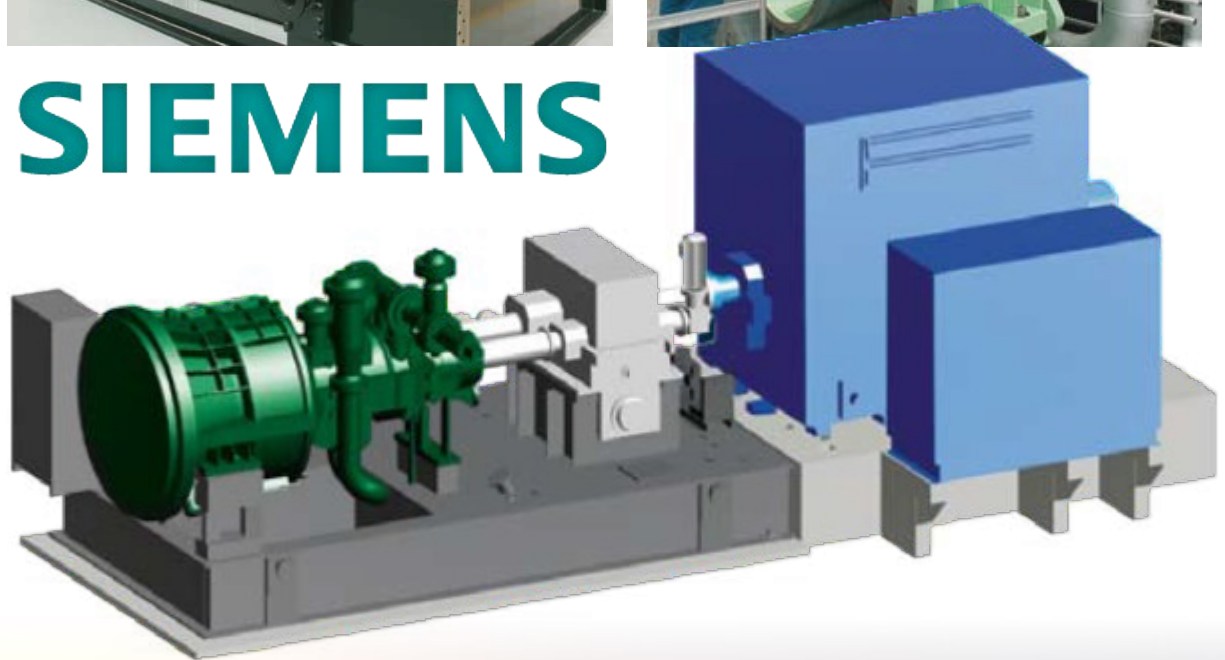

Infrastructure and full Overview

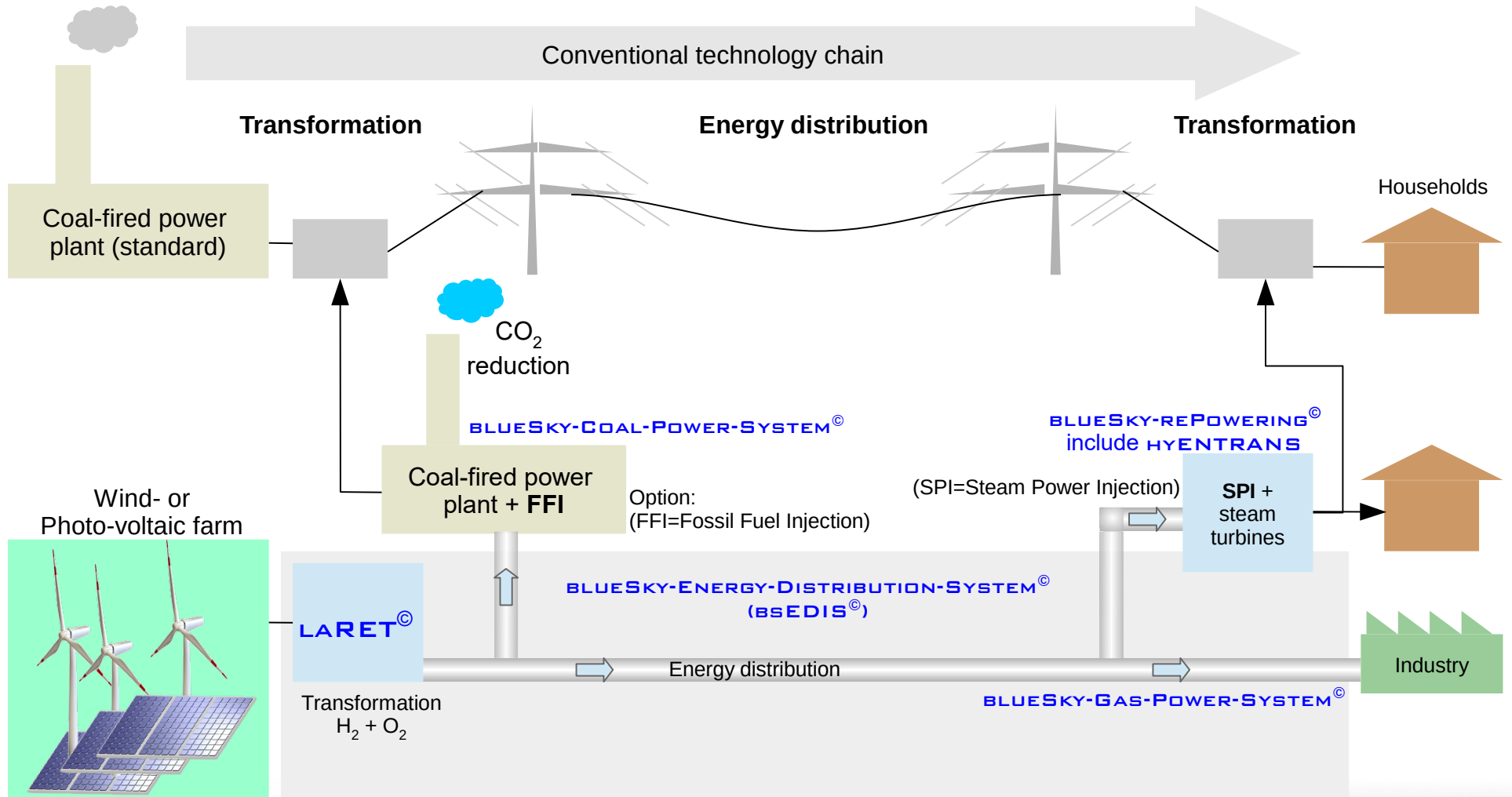

Copyright © 2014-2015 MESY GmbH

MESY's solutions

LARET[®] LARGE RENEWABLE ENERGY TRANSFORMER

- **Function:** Transformation of green energy into storable gases (hydrogen and oxygen).

BLUESKY-ENERGY-DISTRIBUTION-SYSTEM[®] (bsEDIS[®]) includes

- **Function:** Transportation, storing and distribution of hydrogen and oxygen gases over 1000ends of km with pipelines. This system covers standard gas interfaces for industry applications.
- Interface: bsEDIS-dPIPE

• BLUESKY-COAL-POWER-SYSTEM[®]

- **Function:** Steam substitution system.
- Interface: bsEDIS-DPIPE
- Includes BLUESKY-HYENTRANS[®]

• BLUESKY-GAS-POWER-SYSTEM[®]

- **Function:** *Gas injection system with operational interfaces.*
- Interface: bsEDIS-DPIPE

• BLUESKY-REPOWERING[®]

- **Function:** Transform hydrogen and oxygen gas into electricity and heat.
- Interface: bsEDIS-DPIPE
- Includes BLUESKY-HYENTRANS[®]



Basic Data

Transformer Infrastructure **LARET**[©]

- Investment Transformer: 600-900 €/kW
- Connecting power: 50 MW
- Energy purchase cost limit ~ 3 cent €/kWh
- H₂ gas production only 6.300 tons per year
- H₂ sales price ~ ≤ 3 €/kg
- Netto turnover incl. tax (hydrogen sales only): ~ 2,7 Mio. €

HYENTRANS Steam Substitution and repowering

- Investment **BLUESKY-HYENTRANS**[©]: ca. 120-160€/kW



Rechtliche Hinweise

This document contains proprietary data of the MESY Group no disclosure, reproduction, or use of any part thereof may be made except by written permission.
Copyright 2014-2015 MESY GmbH.

Alle Rechte vorbehalten. Kein Teil des Werkes darf in irgendeiner Form (Druck, Fotodruck oder in einem anderen Verfahren) ohne schriftliche Genehmigung des Herausgebers übersetzt, reproduziert oder unter Verwendung elektronischer Systeme verarbeitet, vervielfältigt oder verbreitet werden. **Die Weitergabe dieses Dokuments oder die Nutzung der darin enthaltenen Intellectual Properties, in Teilen oder Auszügen davon, ist in keiner Form ohne schriftliche Genehmigung der genannten Autoren gestattet.**

Die Studien werden mit größtmöglicher Sorgfalt erstellt. Trotzdem kann die MESY oder WIPN Group keine Haftung für die Nutzung der Studien übernehmen. Haftungsansprüche gegen die MESY oder WIPN Group, welche sich auf Schäden materieller oder ideeller Art beziehen, die durch die Nutzung oder Nichtnutzung der Studien verursacht wurden, sind grundsätzlich ausgeschlossen, sofern seitens des Autors kein nachweislich fahrlässiges oder grob fahrlässiges Verschulden vorliegt.

Alle innerhalb der Studien genannten und ggf. durch Dritte geschützten Marken- und Warenzeichen unterliegen uneingeschränkt den Besitzrechten der jeweiligen eingetragenen Eigentümer. Allein aufgrund der bloßen Nennung ist nicht der Schluss zu ziehen, dass Markenzeichen nicht durch Rechte Dritter geschützt sind!

Autor: Kay Golze

E-Mail: kay.golze@mesy.org

Tel.: +49 30 2556 2719

MESY GmbH

Web-page: www.mesy.org

